

Installation Instructions - Kurba RGB&RGBW

Models KBX-X-X-RGB and KBX-X-X-RGBW

Please read all instructions prior to installation and keep for future reference!



REVO.4
03152024

1 / 7



7777 Merrimac Ave
Niles, IL 60714
T 224.333.6033
F 224.757.7557
info@luminii.com
www.luminii.com

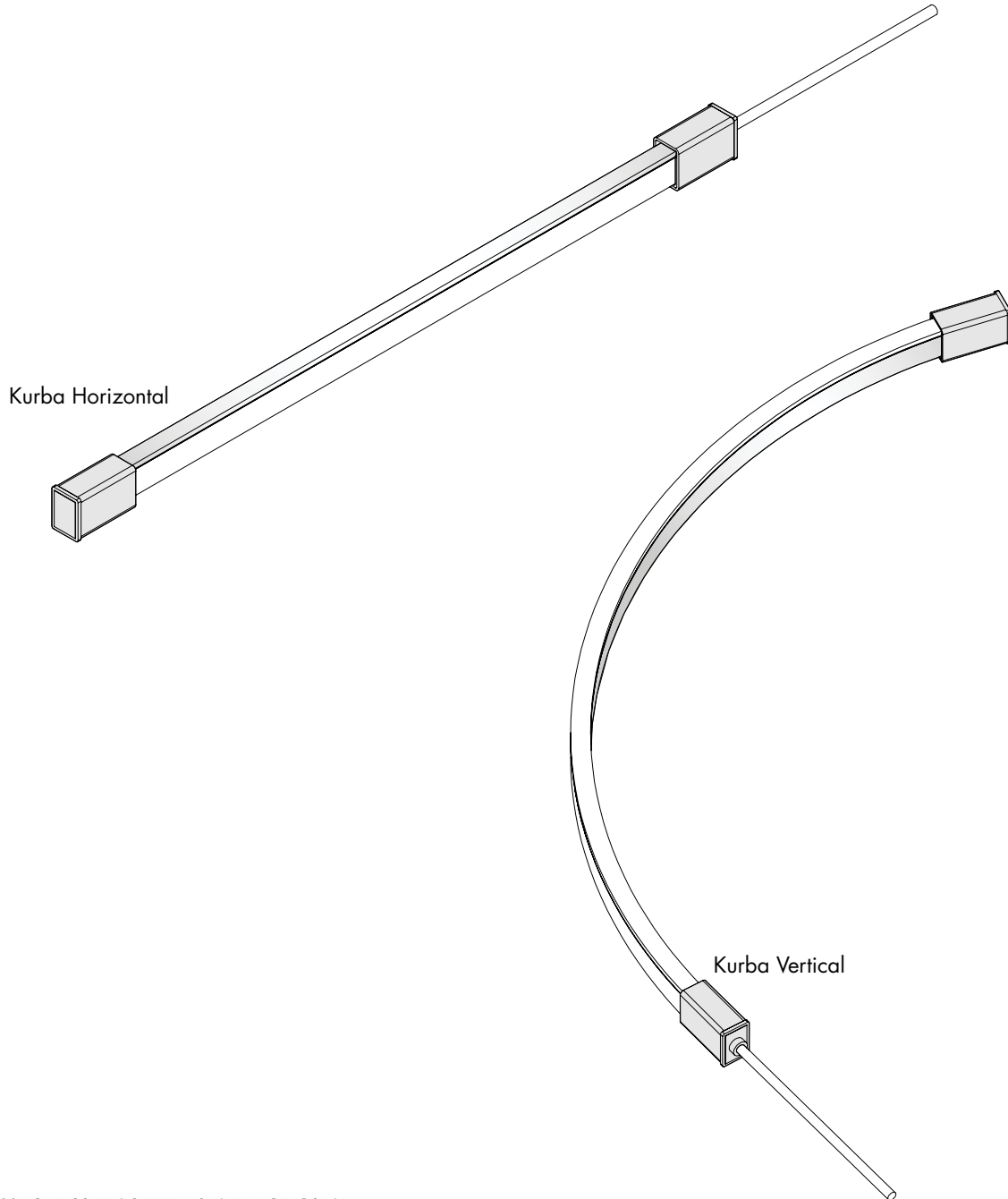

IMPORTANT SAFETY INSTRUCTIONS!

WHEN INSTALLING OR USING THIS TRACK SYSTEM, BASIC SAFETY PRECAUTIONS SHOULD ALWAYS BE FOLLOWED, INCLUDING:

- A. READ ALL INSTRUCTIONS.
- B. DO NOT INSTALL THIS TRACK IN DAMP OR WET LOCATIONS.
- C. DO NOT INSTALL ANY PART OF THE TRACK SYSTEM LESS THAN 5 FEET ABOVE THE FLOOR.
- D. DO NOT INSTALL ANY LUMINAIRE ASSEMBLY CLOSER THAN 6 INCHES FROM ANY CURTAIN, OR SIMILAR COMBUSTIBLE MATERIAL.
- E. DISCONNECT ELECTRICAL POWER BEFORE ADDING TO OR CHANGING THE CONFIGURATION OF THE TRACK.
- F. DO NOT ATTEMPT TO ENERGIZE ANYTHING OTHER THAN LIGHTING TRACK LUMINAIRES ON THE TRACK. TO REDUCE THE RISK OF FIRE AND ELECTRIC SHOCK, DO NOT ATTEMPT TO CONNECT POWER TOOLS, EXTENSION CORDS, APPLIANCES, AND THE LIKE TO THE TRACK.

Installation Instructions - Kurba RGB&RGBW

Models KBX-X-X-RGB and KBX-X-X-RGBW



7777 Merrimac Ave
Niles, IL 60714
T 224.333.6033
F 224.757.7557
info@luminii.com
www.luminii.com

REVO.4
03152024

2 / 7

Please read all instructions prior to installation and keep for future reference!

1. PRODUCT TO BE INSTALLED BY A QUALIFIED ELECTRICIAN.
2. USE ONLY WITH CLASS 2 POWER UNIT
3. 24 VOLTS DC
4. SUITABLE FOR WET LOCATIONS
5. SURFACE MOUNT ONLY
6. NO ADHESIVE ALLOWED TO AFFIX THE PRODUCT

CAUTION: Reference to below before installing Kurba

When unpacking Kurba, carefully pull it out of the packaging box.
Note: Incorrect unpacking may cause PCB fracture or damage on electronic components, and lead to the failure of light. Gloves are recommended in this step.

Do not pull the cable, otherwise it may disable the function of the connector and lead to water ingress. It's recommended to keep the first 2.5 inches of the cable straight and without tension.

Kurba Horizontal

CAN Bend LED in these positions to avoid damage

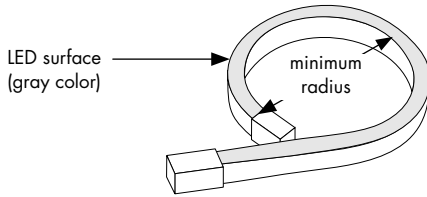

Bend in this direction only

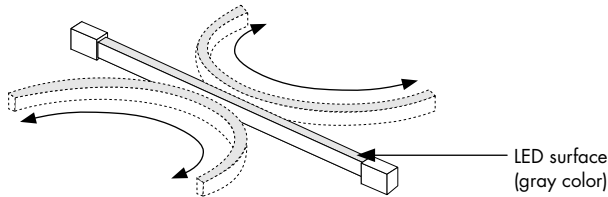

Product Name	Minimum Radius
Kurba Max	8in
Kurba Large	6in
Kurba Medium	2.5in
Kurba Small	2.0in

CANNOT Twisting or bending LED in these positions will cause damage to the LED

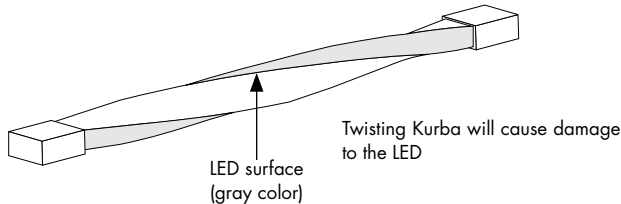

Do not make sharp bends near the endcap

Bending in the same direction as the LED will cause damage to the LED

Kurba Vertical

CAN Bend LED in these positions to avoid damage

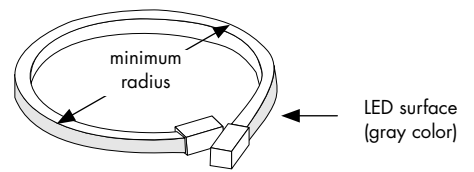

Bend in this direction only

CANNOT Twisting or bending LED in these positions will cause damage to the LED

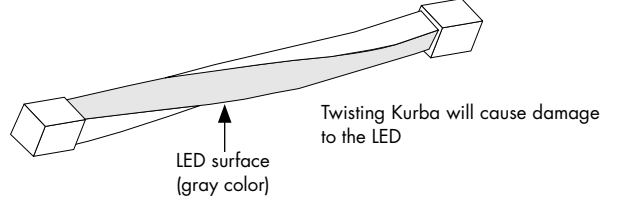

Do not make sharp bends near the endcap

Bending in the same direction as the LED will cause damage to the LED

Installation Instructions - Kurba RGB&RGBW

Models KBX-X-RGB and KBX-X-RGBW



7777 Merrimac Ave
Niles, IL 60714
T 224.333.6033
F 224.757.7557
info@luminii.com
www.luminii.com

REVO.4
03152024

3 / 7

Please read all instructions prior to installation and keep for future reference!

1. PRODUCT TO BE INSTALLED BY A QUALIFIED ELECTRICIAN.
2. USE ONLY WITH CLASS 2 POWER UNIT
3. 24 VOLTS DC
4. SUITABLE FOR WET LOCATIONS
5. SURFACE MOUNT ONLY
6. NO ADHESIVE ALLOWED TO AFFIX THE PRODUCT

1

NOTE: Prior to installation all 24VDC wires must be present within 72" of the installation. Refer to the power supply installation instruction for additional information.

NOTE: More than one person is recommended for this installation.

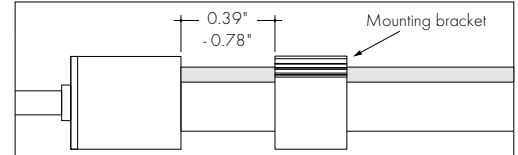

NOTE: Keep a 0.39" - 0.79" spacing between the end of the fixture and the mounting bracket

1.1 Once the location or pattern is determined for Kurba to be installed, start off by marking the area. Amount of brackets may vary dependant upon pattern. Reference diagrams below.

Straight run with mounting channel

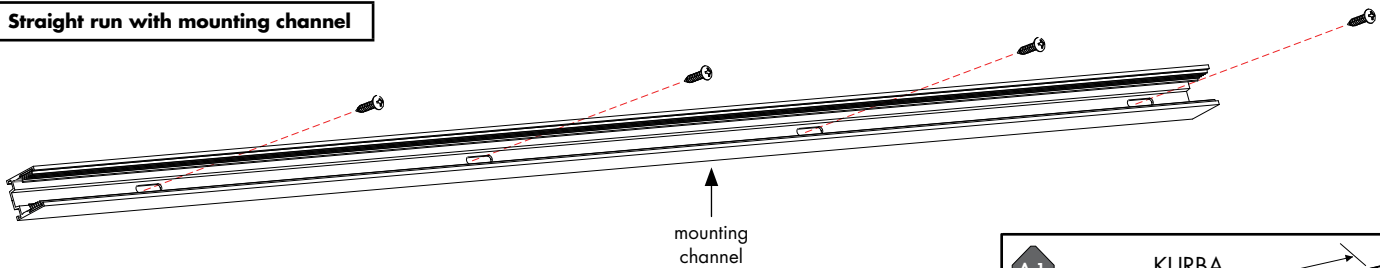

A.1

Mounting Channel Top View

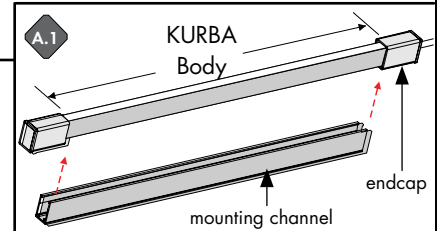
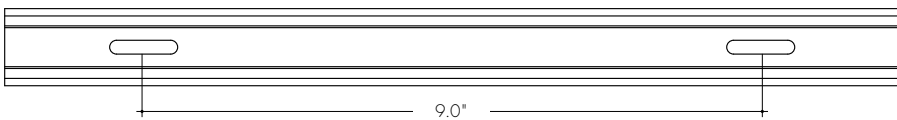

A.1 Drill holes into the surface 9" apart from each other, followed by placing the mounting channel to the surface. Make sure its straight by using a level.

A.2 Secure channel to the surface by tightening all the provided screws. If mounting to something other than wood, we recommend using the proper hardware.

Curved run with mounting brackets

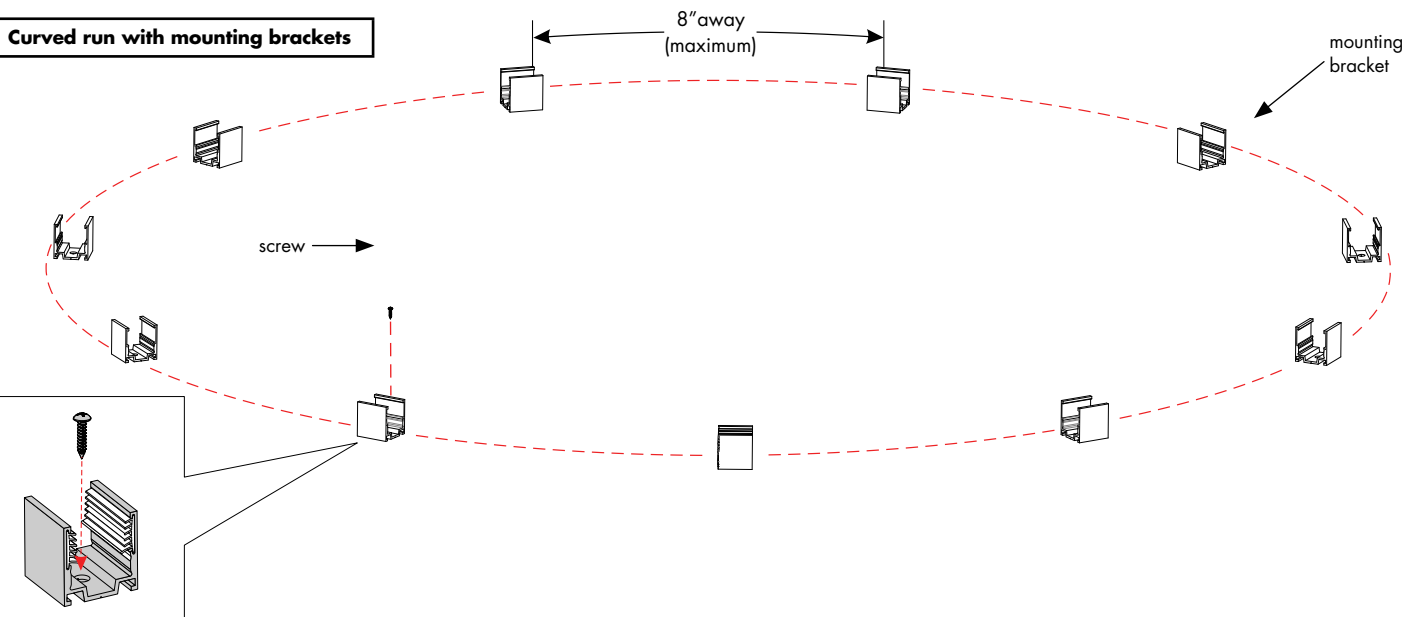

B.1 Determine the shape of the Kurba layout, then mark the pattern onto the surface. Then, place a mounting bracket every 8" (minimum). The pattern may vary dependant upon the amount of curves.

B.2 Secure the mounting brackets to the surface by tightening the screw. If mounting to something other than wood, we recommend using the proper hardware.

Installation Instructions - Kurba RGB&RGBW

Models KBX-X-X-RGB and KBX-X-X-RGBW

Please read all instructions prior to installation and keep for future reference!

1. PRODUCT TO BE INSTALLED BY A QUALIFIED ELECTRICIAN.
2. USE ONLY WITH CLASS 2 POWER UNIT
3. 24 VOLTS DC
4. SUITABLE FOR WET LOCATIONS
5. SURFACE MOUNT ONLY
6. NO ADHESIVE ALLOWED TO AFFIX THE PRODUCT



REVO.4
03152024

4 / 7



7777 Merrimac Ave
Niles, IL 60714
T 224.333.6033
F 224.757.7557
info@luminii.com
www.luminii.com

Bendable Mounting Channel with Grip

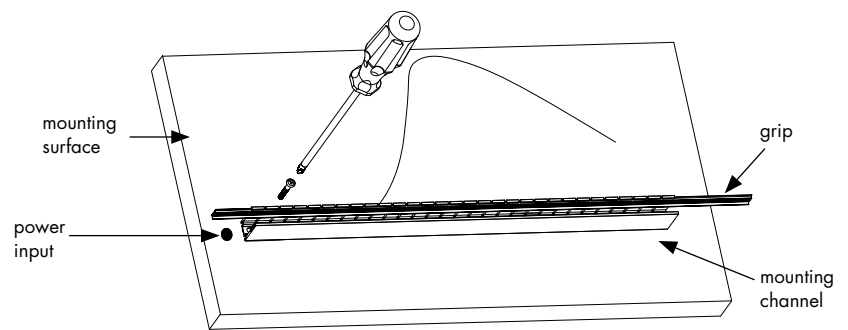
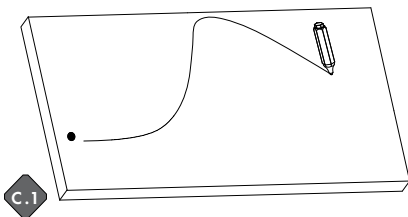
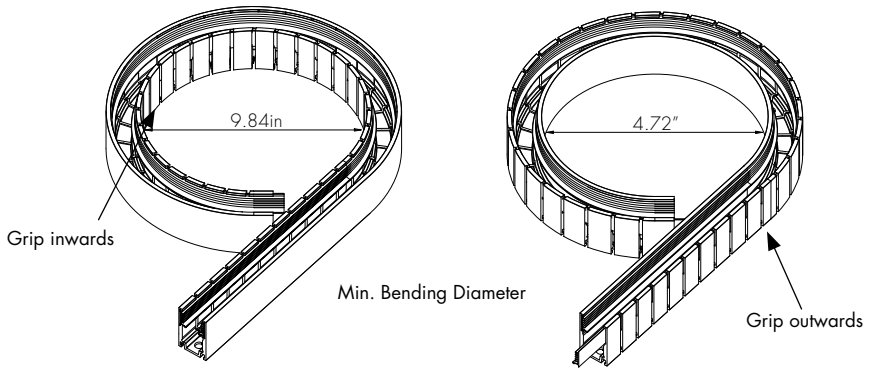
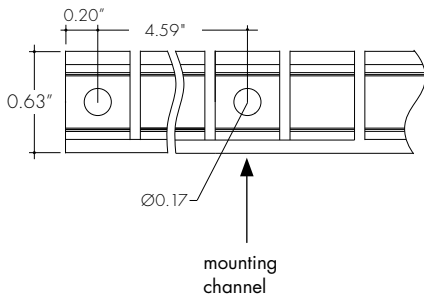

- C.1** Mark the required shape on the mounting surface.
- C.2** Fix the screw starting from the power input end. Keep some distance between the channel and power input.

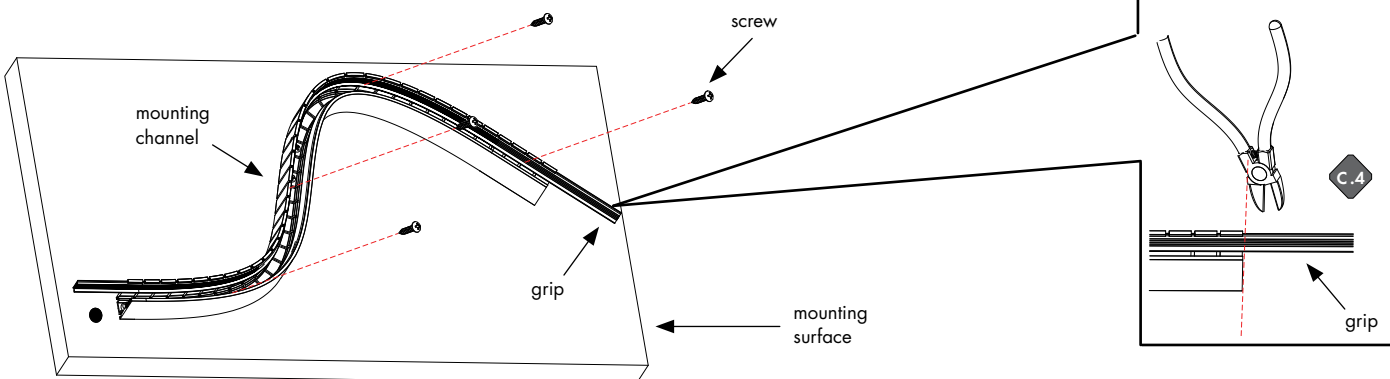

- C.3** Fix the rest in sequence along with the marks.
- C.4** Adjust the serrate silicone tape and remove the extra lengths at both ends.

Installation Instructions - Kurba RGB&RGBW

Models KBX-X-X-RGB and KBX-X-X-RGBW

Please read all instructions prior to installation and keep for future reference!

1. PRODUCT TO BE INSTALLED BY A QUALIFIED ELECTRICIAN.
2. USE ONLY WITH CLASS 2 POWER UNIT
3. 24 VOLTS DC
4. SUITABLE FOR WET LOCATIONS
5. SURFACE MOUNT ONLY
6. NO ADHESIVE ALLOWED TO AFFIX THE PRODUCT



REVO.4
03152024

5 / 7



7777 Merrimac Ave
Niles, IL 60714
T 224.333.6033
F 224.757.7557
info@luminii.com
www.luminii.com

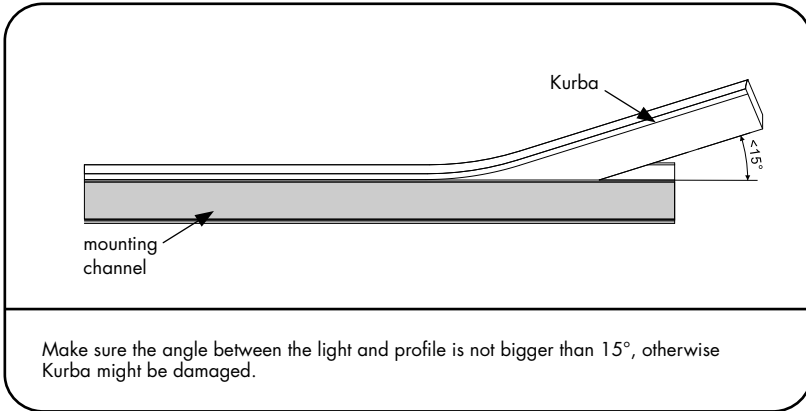

Make sure the angle between the light and profile is not bigger than 15° , otherwise Kurba might be damaged.

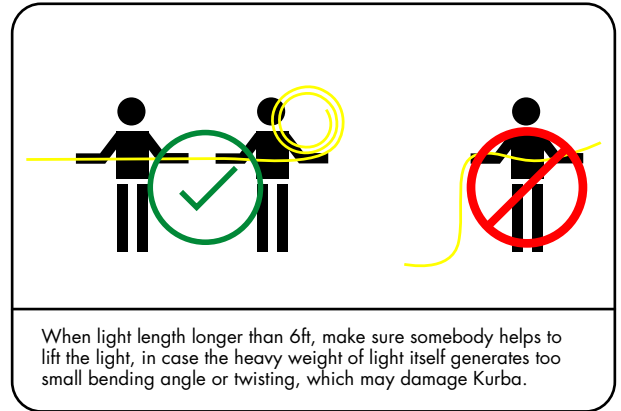

When light length longer than 6ft, make sure somebody helps to lift the light, in case the heavy weight of light itself generates too small bending angle or twisting, which may damage Kurba.

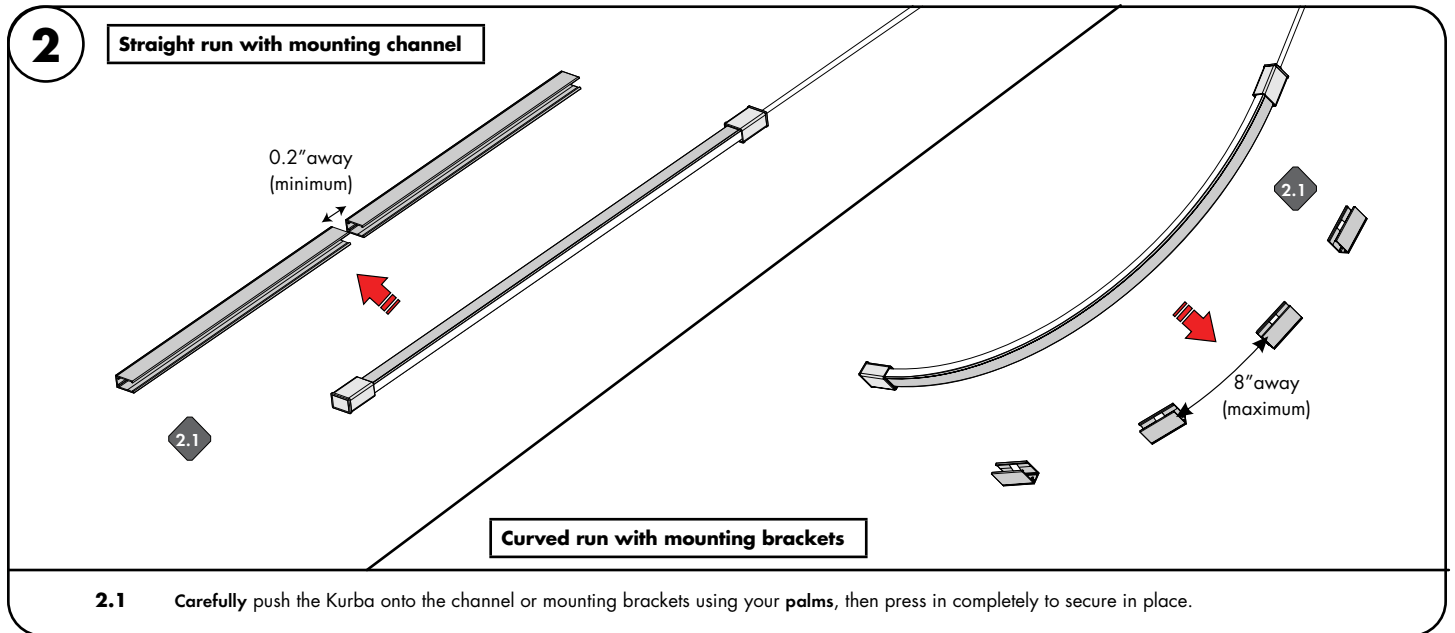

2.1 Carefully push the Kurba onto the channel or mounting brackets using your palms, then press in completely to secure in place.

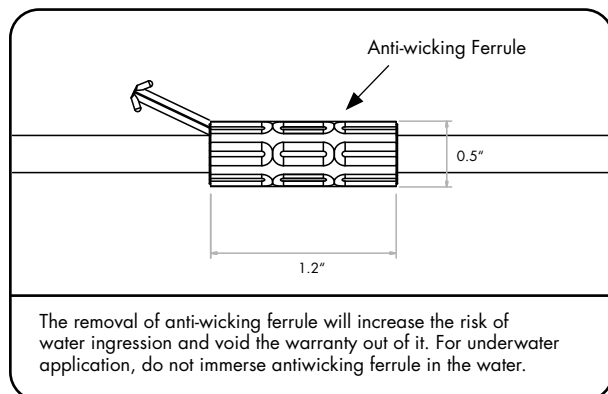

The removal of anti-wicking ferrule will increase the risk of water ingress and void the warranty out of it. For underwater application, do not immerse antiwicking ferrule in the water.

Installation Instructions - Kurba RGB&RGBW

Models KBX-X-X-RGB and KBX-X-X-RGBW

Please read all instructions prior to installation and keep for future reference!

1. PRODUCT TO BE INSTALLED BY A QUALIFIED ELECTRICIAN.
2. USE ONLY WITH CLASS 2 POWER UNIT
3. 24 VOLTS DC
4. SUITABLE FOR WET LOCATIONS
5. SURFACE MOUNT ONLY
6. NO ADHESIVE ALLOWED TO AFFIX THE PRODUCT



REVO.4
03152024

6 / 7



7777 Merrimac Ave
Niles, IL 60714
T 224.333.6033
F 224.757.7557
info@luminii.com
www.luminii.com

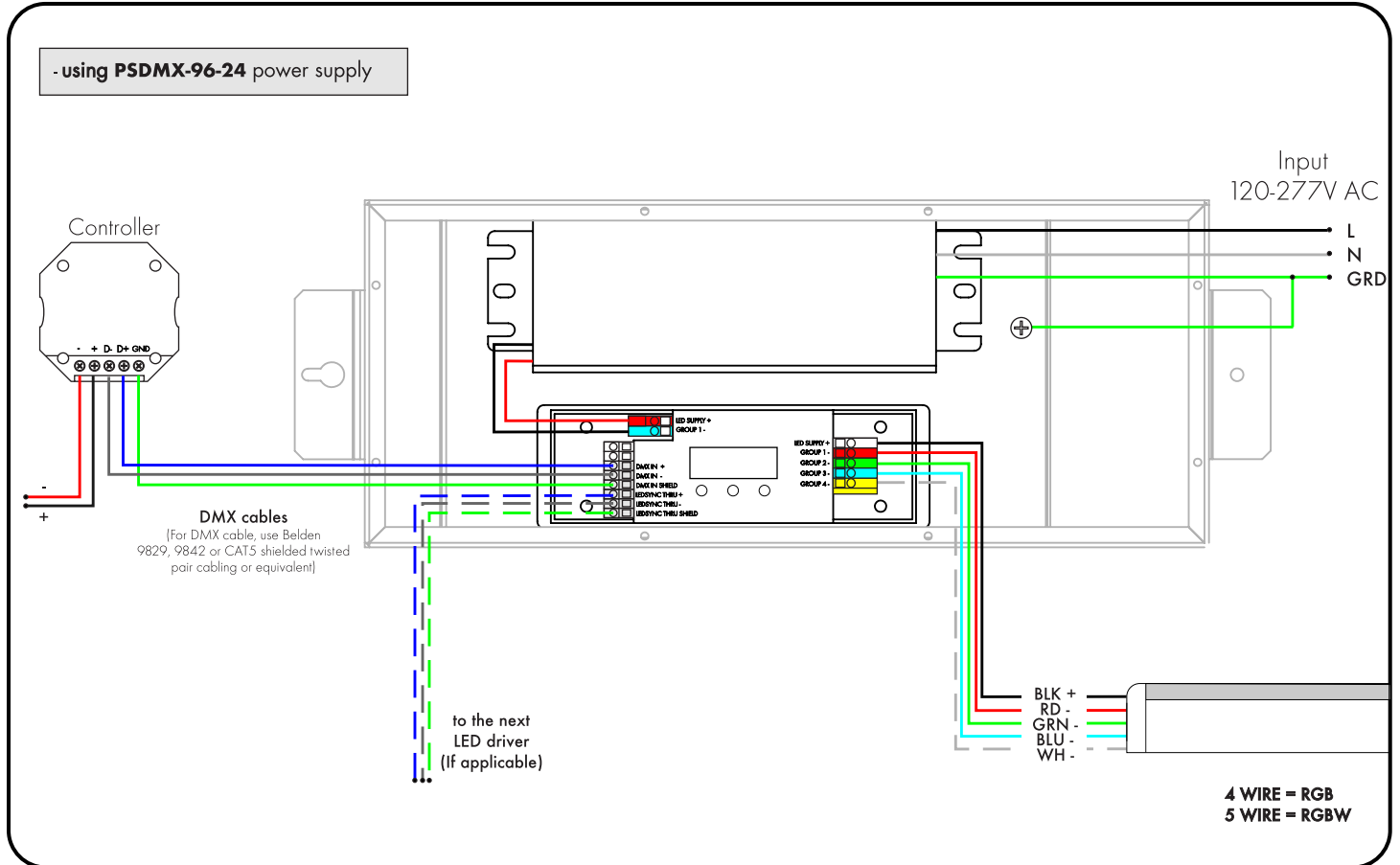

Installation Instructions - Kurba RGB&RGBW

Models KBX-X-X-RGB and KBX-X-X-RGBW

Please read all instructions prior to installation and keep for future reference!

1. PRODUCT TO BE INSTALLED BY A QUALIFIED ELECTRICIAN.
2. USE ONLY WITH CLASS 2 POWER UNIT
3. 24 VOLTS DC
4. SUITABLE FOR WET LOCATIONS
5. SURFACE MOUNT ONLY
6. NO ADHESIVE ALLOWED TO AFFIX THE PRODUCT



REVO.4
03152024

7 / 7



7777 Merrimac Ave
Niles, IL 60714
T 224.333.6033
F 224.757.7557
info@luminii.com
www.luminii.com

Removing Kurba from Mounting Brackets

